

BRQ Series

Cylindrical Type Photoelectric Sensor

■ Features

[Common]

- Excellent noise immunity and minimal influence from ambient light
- Power/Output reverse polarity protection circuit, output short over current protection circuit
- Mutual interference prevention function (except through-beam type)
- Sensitivity adjuster
- Light ON, Dark ON switchable by control wire

[BRQT, BRQM, BRQP Series (front sensing type)]

- Various materials: Plastic, Metal (Ni-plated Brass), Stainless steel 316L
- Long sensing distance: 30m (through-beam type)
- Body size - BRQT, BRQM: Standard
BRQP: Standard, Short body
- Protection structure - BRQT: IP67 (IEC standard), IP69K (DIN standard)
BRQM, BRQP: IP67 (IEC standard)

[BRQPS Series (side sensing type)]

- Protection structure: IP67 (IEC standard)

 Please read "Safety Considerations" in the instruction manual before using.



[BRQT, BRQM, BRQP Series (front sensing type)]



BRQT-A
SUS316L Standard



BRQM-A
Ni-plate Brass Standard



BRQT-A
Plastic Standard



BRQP-B
Plastic Short-body



Reflector (MS-2A)



Reflective tape (MST series)

[BRQPS Series (side sensing type)]



Reflector (MS-2S)



Reflective tape (MST series)

※The model name with '-C' is connector type.
※Reflective tape (MST series) is sold separately.

■ Ordering Information



	Front sensing type	Side sensing type
No mark	NPN open collector output	
P	PNP open collector output	
No mark	Cable type	
C	Connector type	
A	Standard	Standard
B	Short body ^{※1}	—
1	Emitter	
2	Receiver	
T	Transistor output	
D	DC power	
T	Through-beam type	
P	Retroreflective type (built-in polarizing filter)	
D	Diffuse reflective type	
No mark	mm	
M	m	
Number	Sensing distance	
No mark	Front sensing type	—
S	—	Side sensing type
T	Stainless steel 316L	—
M	Brass, Ni-plate	—
P	Plastic	Plastic
BRQ	Cylindrical type photoelectric sensor	

※1: This is only for BRQP Series.

※: This information is intended for product management of through-beam type. (no need to refer when selecting model)

Cylindrical Type Photoelectric Sensor (Front Sensing Type)

Cylindrical Type Photoelectric Sensor (front sensing type)

■ Specifications

Model	NPN open collector output	BRQ□5M-TDT□□□	BRQ□20M-TDT□□□	BRQ□30M-TDT□□□	BRQ□3M-PDT□□□	BRQ□100-DDT□□□	BRQ□400-DDT□□□	BRQ□1M-DDT□□□
	PNP open collector output	BRQ□5M-TDT□□□-P	BRQ□20M-TDT□□□-P	BRQ□30M-TDT□□□-P	BRQ□3M-PDT□□□-P	BRQ□100-DDT□□□-P	BRQ□400-DDT□□□-P	BRQ□1M-DDT□□□-P
Sensing type	Through-beam type				Retroreflective type (built-in polarizing filter)	Diffuse reflective type		
Sensing distance	5m	20m	30m	3m ^{※1}	100mm ^{※2}	400mm ^{※2}	1m ^{※3}	
Sensing target	Opaque materials of min. Ø7mm				Opaque materials of min. Ø75mm	Opaque, translucent materials		
Hysteresis	—				Max. 20% at rated sensing distance			
Response time	Max. 1ms							
Power supply	10-30VDC \pm 10% (ripple P-P: max.10%)							
Current consumption	Emitter/Receiver: max. 20mA				Max. 30mA			
Light source	Red LED (660nm)					Infrared LED (850nm)	Red LED (660nm)	
Sensitivity adjustment	Sensitivity adjuster							
Operation mode	Selectable Light ON or Dark ON by control wire (white)							
Control output	NPN or PNP open collector output · Load voltage: max. 30VDC \pm · Load current: max. 100mA · Residual voltage: max. 2VDC \pm							
Protection circuit	Power/Output reverse polarity protection circuit, output short over current protection circuit, interference prevention function (except through-beam type)							
Indicator	Operation indicator: yellow LED, stability indicator: green LED (emitter power indicator of through-beam type: red LED)							
Connection	Cable type, connector type							
Insulation resistance	Over 20MΩ (at 500VDC megger)							
Noise immunity	\pm 240V the square wave noise (pulse width:1μs) by the noise simulator							
Dielectric strength	1,000VAC 50/60Hz for 1 minute							
Vibration	1.5mm amplitude at frequency of 10 to 55Hz in each X, Y, Z direction for 2 hours							
Shock	500m/s ² (approx. 50G) in X, Y, Z direction for 3 times							
Environment	Ambient illu.	Sunlight: max. 11,000lx, Incandescent lamp: max. 3,000lx (receiver illumination)						
	Ambient temp.	-25 to 60°C, storage: -30 to 70°C						
	Ambient humi.	35 to 85%RH, storage: 35 to 85%RH						
Protection structure	· BRQT Series: IP67 (IEC standard), IP69K (DIN standard) · BRQM, BRQP Series: IP67 (IEC standard)							
Material	· Case: BRQT Series - stainless steel 316L / BRQM Series - brass, Ni-plate / BRQP Series - polycarbonate · Lens, Lens cover: polymethyl methacrylate acrylic							
Cable ^{※4}	Cable type	Ø4mm, 4-wire, 2m (emitter of through-beam type: Ø4mm, 2-wire, 2m) (AWG26, core diameter: 0.52mm, number of cores: 20, insulator out diameter: Ø1mm)						
	Accessory	Individual	—			Reflector (MS-2A)	—	
	Common	M18 fixing nut: 4, adjustment screwdriver				M18 fixing nut: 2, adjustment screwdriver		
Approval	CE  us							
Weight ^{※5}	Cable type	BRQT-A/BRQM-A: approx. 220g (approx. 140g) BRQP-A: approx. 160g (approx. 110g) BRQP-B: approx. 150g (approx. 100g)			BRQT-A/BRQM-A: approx. 150g (approx. 70g) BRQP-A: approx. 120g (approx. 60g) BRQP-B: approx. 120g (approx. 50g)			
		Connector type	BRQT-A/BRQM-A: approx. 160g (approx. 50g) BRQP-A: approx. 110g (approx. 25g) BRQP-B: approx. 100g (approx. 20g)			BRQT-A/BRQM-A: approx. 140g (approx. 30g) BRQP-A: approx. 110g (approx. 15g) BRQP-B: approx. 100g (approx. 10g)		

※1: The sensing distance is specified with using the MS-2A reflector. The distance between the sensor and the reflector should be set over 0.1m. When using reflective tapes, the reflectivity will vary by the size of the tape. Please refer to the '■ Reflectivity by Reflective Tape Model' table before using the tape.

※2: Non-glossy white paper 100×100mm.

※3: Non-glossy white paper 300×300mm.

※4: M12 connector cable is sold separately.

※5: The weight includes packaging. The weight in parenthesis is for unit only.

※The temperature or humidity mentioned in Environment indicates a non freezing or condensation.

SENSORS

CONTROLLERS

MOTION DEVICES

SOFTWARE

(A) Photoelectric Sensors

(B) Fiber Optic Sensors

(C) LIDAR

(D) Door/Area Sensors

(E) Vision Sensors

(F) Proximity Sensors

(G) Pressure Sensors

(H) Rotary Encoders

(I) Connectors/ Connector Cables/ Sensor Distribution Boxes/ Sockets

BRQ Series

(unit: mm)

■ Dimensions

◎ Through-beam type

- BRQT□-TDTA(-P)
- BRQM□-TDTA(-P)

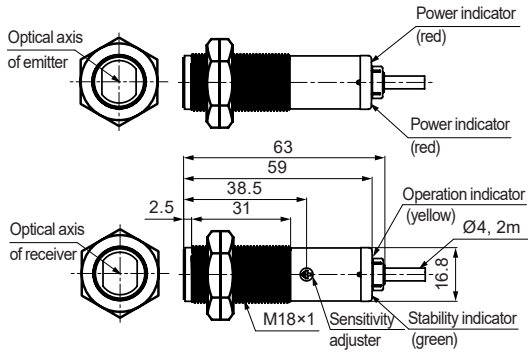

- BRQT□-TDTA-C(-P)
- BRQM□-TDTA-C(-P)

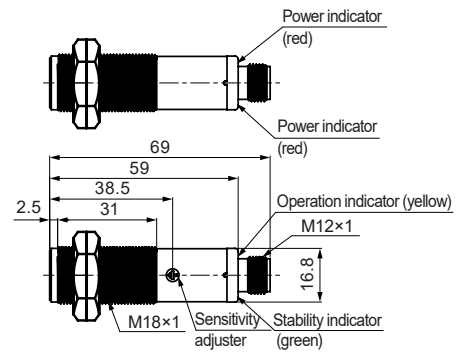

• BRQP□-TDTA(-P)

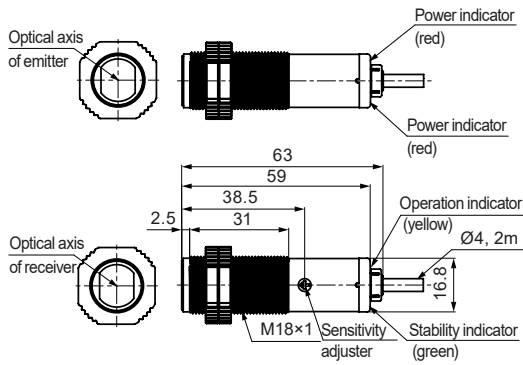

• BRQP□-TDTA-C(-P)

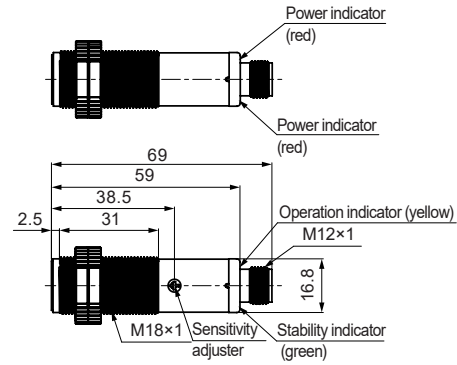

• BRQP□-TDTB(-P)

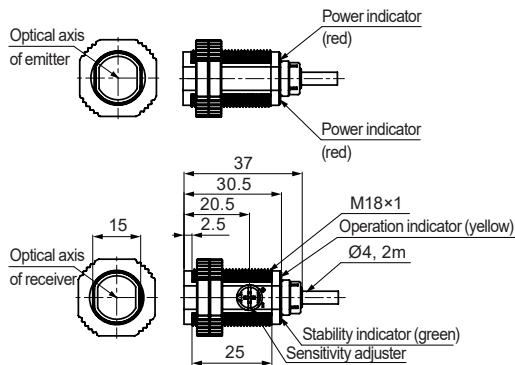

• BRQP□-TDTB-C(-P)

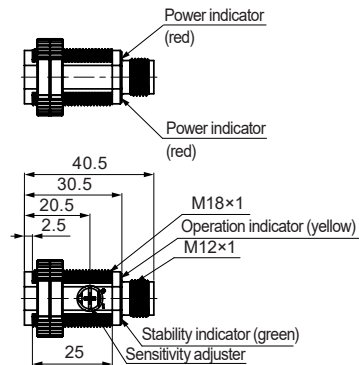

Cylindrical Type Photoelectric Sensor (Front Sensing Type)

◎ Retroreflective/Diffuse reflective type

(unit: mm)

- BRQT3M-PDTA(-P)/BRQM3M-PDTA(-P)
- BRQT□-DDTA(-P)/BRQM□-DDTA(-P)

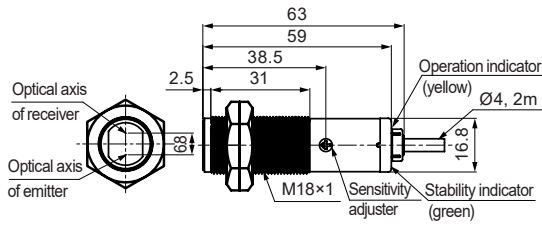

- BRQT3M-PDTA-C(-P)/BRQM3M-PDTA-C(-P)
- BRQT□-DDTA-C(-P)/BRQM□-DDTA-C(-P)



- BRQP3M-PDTA(-P)
- BRQP□-DDTA(-P)



- BRQP3M-PDTA-C(-P)
- BRQP□-DDTA-C(-P)



- BRQP3M-PDTB(-P)
- BRQP□-DDTB(-P)



- BRQP3M-PDTB-C(-P)
- BRQP□-DDTB-C(-P)



SENSORS

CONTROLLERS

MOTION DEVICES

SOFTWARE

(A) Photoelectric Sensors

(B) Fiber Optic Sensors

(C) LIDAR

(D) Door/Area Sensors

(E) Vision Sensors

(F) Proximity Sensors

(G) Pressure Sensors

(H) Rotary Encoders

(I) Connectors/ Connector Cables/ Sensor Distribution Boxes/ Sockets

BRQ Series

• M18 fixing nut



◎ Sold separately

• Bracket(BK-BR-A)

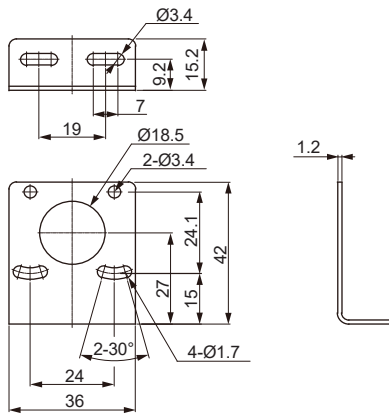

• Reflector

(unit: mm)

• MS-2A



• Fixing cap

(BK-BR-B, only for BRQP□□□□B□)

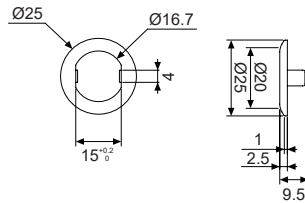

• Connection cable

• CIDH4□



• CLDH4□



※Specification of connector cable: Ø6mm, 4-wire, 2m/3m/5m/7m
(AWG22, core diameter: 0.08mm, number of cores: 60, insulator out diameter: Ø1.65mm)

• Reflective tape

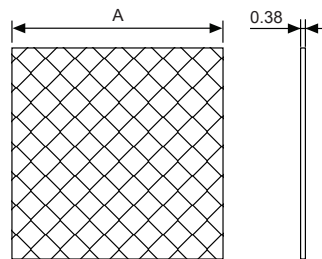

(unit: mm)

Model	A
MST-50-10	□50
MST-100-5	□100
MST-200-2	□200

Cylindrical Type Photoelectric Sensor (Front Sensing Type)

■ Feature Data

◎ Through-beam type

● BRQ□5M-TDT□□(-P)

Parallel shifting characteristic		Angle characteristic	
Measuring method	Data	Measuring method	Data

● BRQ□20M-TDT□□(-P)

Parallel shifting characteristic		Angle characteristic	
Measuring method	Data	Measuring method	Data

● BRQ□30M-TDT□□(-P)

Parallel shifting characteristic		Angle characteristic	
Measuring method	Data	Measuring method	Data

◎ Retroreflective type

● BRQ□3M-PDT□□-P

Parallel shifting characteristic		Sensor angle characteristic		Reflector angle characteristic	
Measuring method	Data	Measuring method	Data	Measuring method	Data

SENSORS

CONTROLLERS

MOTION DEVICES

SOFTWARE

(A) Photoelectric Sensors

(B) Fiber Optic Sensors

(C) LIDAR

(D) Door/Area Sensors

(E) Vision Sensors

(F) Proximity Sensors

(G) Pressure Sensors

(H) Rotary Encoders

(I) Connectors/ Connector Cables/ Sensor Distribution Boxes/ Sockets

BRQ Series

◎ Diffuse reflective type

● BRQ□100-DDT□□(-P)

● BRQ□400-DDT□□(-P)

● BRQ□1M-DDT□□(-P)

Sensing area characteristic		Sensing area characteristic		Sensing area characteristic	
Measuring method	Data	Measuring method	Data	Measuring method	Data

■ Control Output Circuit Diagram

● Through-beam/Retroreflective/Diffuse reflective type

NPN open collector output		PNP open collector output	
Photoelectric sensor circuit	Connection	Photoelectric sensor circuit	Connection
	(brown) +V (black) Output Load Max. 100mA 10-30VDC (blue) 0V (white) Control		(brown) +V Dark ON Max. 100mA 10-30VDC (black) Output Load (blue) 0V Light ON (white) Control

※ Before using this unit, select Light ON/Dark ON with control cable.

(Light ON: connect control cable with 0V/Dark ON: connect control cable with +V)

※ If short-circuit the control output terminal or supply current over the rated specification, normal control signal is not output due to the output short over current protection circuit.

■ Connections for Connector Part

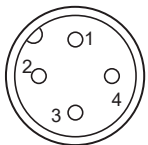

M12 Connector pin

Pin No.	Cable color	Application Diffuse/ Retroreflective type	Through-beam type	
			Emitter	Receiver
1	Brown	30VDC	30VDC	30VDC
2	White	CONTROL	N.C	CONTROL
3	Blue	GND	GND	GND
4	Black	OUTPUT	N.C	OUTPUT

● Connector cable (sold separately)

※ Please refer to the connector cable part.

Cylindrical Type Photoelectric Sensor (Front Sensing Type)

■ Operation Timing Diagram

◎ Through-beam type



◎ Retroreflective/Diffuse reflective type



※The waveforms of 'Operation indicator' and 'Transistor output' are for Light ON operation. They are opposite operation for Dark ON operation.

SENSORS
CONTROLLERS
MOTION DEVICES
SOFTWARE

(A) Photoelectric Sensors
(B) Fiber Optic Sensors
(C) LIDAR
(D) Door/Area Sensors
(E) Vision Sensors
(F) Proximity Sensors
(G) Pressure Sensors
(H) Rotary Encoders
(I) Connectors/Connector Cables/Sensor Distribution Boxes/ Sockets

BRQ Series

■ Connections

• Through-beam type

<Cable type>



<Connector type>



• Retroreflective type

<Cable type>



<Connector type>

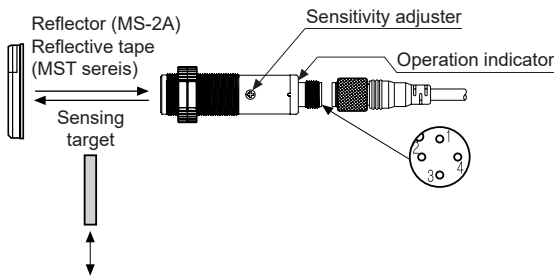

• Diffuse reflective type

<Cable type>



<Connector type>



Cylindrical Type Photoelectric Sensor (Front Sensing Type)

■ Installation and Adjustment

Install the sensor to the desired place and check the connections. Supply the power to the sensor and adjust the optical axis and the sensitivity as following.

When using the reflective type photoelectric sensors closely over three units, it may result in malfunction due to mutual interference.

When using the through-beam type photoelectric sensors closely over two units, it may result in malfunction due to mutual interference.

When installing the product, tighten the screw with a tightening torque of 14.7N·m for BRQT/BRQM and 0.39N·m for BRQP.

○ Through-beam type

1. Supply the power to the photoelectric sensor, after setting the emitter and the receiver facing each other.
2. Set the receiver in center of position in the middle of the operation range of indicator adjusting the receiver or the emitter right and left, up and down.
3. After adjustment, check the stability of operation putting the object at the optical axis.

※If the sensing target is translucent body or smaller than $\varnothing 7\text{mm}$, it can be missed by sensor cause light penetrate it.



○ Retroreflective type

1. Supply the power to the photoelectric sensor, after setting the photoelectric sensor and the reflector (MS-2A) or reflective tape in face to face.
2. Set the photoelectric sensor in the position which indicator turns on, as adjusting the reflector or the sensor right and left, up and down.
3. Fix both units tightly after checking that the unit detects the target.

※Sensitivity adjustment

: Refer to the diffuse reflective type's.



○ Diffuse reflective type

1. The sensitivity should be adjusted depending on a sensing target or mounting place.



2. Set the target at a position to be detected by the beam, then turn the sensitivity adjuster until position ㊸ where the operation indicator turns ON from min. position of the Sensitivity adjuster.
3. Take the target out of the sensing area, then turn the Sensitivity adjuster until position ㊹ where the operation indicator turns ON. If the indicator dose not turn ON, max. position is ㊺.
4. Set the sensitivity adjuster at the center of two switching position ㊸, ㊹.

※Be aware of the fact that sensing distance can be different by size, surface and gloss of the target.



■ Reflectivity by Reflective Tape Model

Model	Standard	Short body
MST-50-10 (50×50mm)	40%	40%
MST-100-5 (100×100mm)	50%	80%
MST-200-2 (200×200mm)	80%	85%

※This reflectivity is based on the reflector (MS-2A).

※Reflectivity may vary depending on usage environment and installation conditions.

The sensing distance and minimum sensing target size increase as the size of the tape increases.

Please check the reflectivity before using reflective tapes.

※For using reflective tape, installation distance should be min. 20mm.

SENSORS

CONTROLLERS

MOTION DEVICES

SOFTWARE

(A) Photoelectric Sensors

(B) Fiber Optic Sensors

(C) LIDAR

(D) Door/Area Sensors

(E) Vision Sensors

(F) Proximity Sensors

(G) Pressure Sensors

(H) Rotary Encoders

(I) Connectors/ Connector Cables/ Sensor Distribution Boxes/ Sockets

BRQ Series

Cylindrical Type Photoelectric Sensor (side sensing type)

■ Specifications

Model	NPN open collector output	BRQPS10M-TDTA(-C)	BRQPS20M-TDTA(-C)	BRQPS3M-PDTA(-C)	BRQPS100-DDTA(-C)	BRQPS400-DDTA(-C)	BRQPS700-DDTA(-C)
	PNP open collector output	BRQPS10M-TDTA(-C)-P	BRQPS20M-TDTA(-C)-P	BRQPS3M-PDTA(-C)-P	BRQPS100-DDTA(-C)-P	BRQPS400-DDTA(-C)-P	BRQPS700-DDTA(-C)-P
Sensing type	Through-beam type			Retroreflective type (built-in polarizing filter)	Diffuse reflective type		
Sensing distance	10m	20m	3m ^{※1}	100mm ^{※2}	400mm ^{※2}	700mm ^{※3}	
Sensing target	Opaque materials of min. Ø7mm			Opaque materials of min. Ø75mm	Opaque, translucent materials		
Hysteresis	—			Max. 20% of maximum sensing distance			
Response time	Max. 1ms						
Power supply	10-30VDC= ±10% (ripple P-P: max. 10%)						
Current consumption	Emitter/Receiver: max. 20mA			Max. 30mA			
Light source	Red LED (660nm)						
Sensitivity adjustment	Sensitivity adjuster						
Operation mode	Selectable Light ON or Dark ON by control wire (white)						
Control output	NPN or PNP open collector output • Load voltage: max. 30VDC= • Load current: max. 100mA • Residual voltage: max. 2VDC=						
Protection circuit	Power/Output reverse polarity protection circuit, output short over current protection circuit, interference prevention function (except through-beam type)						
Indicator	Operation indicator: yellow LED, stability indicator: green LED (emitter power indicator of through-beam type: red LED)						
Connection	Cable type, connector type						
Insulation resistance	Over 20MΩ (at 500VDC megger)						
Noise immunity	±240V the square wave noise (pulse width: 1μs) by the noise simulator						
Dielectric strength	1,000VAC 50/60Hz for 1 minute						
Vibration	1.5mm amplitude at frequency of 10 to 55Hz in each X, Y, Z direction for 2 hours						
Shock	500m/s ² (approx. 50G) in X, Y, Z directions for 3 times						
Environment	Ambient illu.	Sunlight: max.11,000lx, incandescent lamp: 3,000lx (receiver illumination)					
	Ambient temp.	-25 to 60°C, storage: -30 to 70°C					
	Ambient humi.	35 to 85%RH, storage: 35 to 85%RH					
Protection structure	IP67 (IEC standard)						
Material	Case: polycarbonate, lens, lens cover: polymethyl methacrylate acrylic						
Cable ^{※4}	Ø4mm, 4-wire, 2m (emitter of through-beam type: Ø4mm, 2-wire, 2m) (AWG26, core diameter: 0.52mm, number of cores: 20, insulator out diameter: Ø1mm)						
Accessory	Individual	—		Reflector (MS-2S)	—		
	Common	M18 fixing nut: 4, adjustment screwdriver		M18 fixing nut: 2, adjustment screwdriver			
Approval							
Weight ^{※5}	Cable type	Approx. 170g (approx. 120g)		Approx. 130g (approx. 70g)			
	Connector type	Approx. 120g (approx. 35g)		Approx. 120g (approx. 25g)			

※1: The sensing distance is specified with the MS-2S reflector. The distance between the sensor and the reflector should be set over 0.1m. When using reflective tapes, the reflectivity will vary by the size of the tape. Please refer to the '■ Reflectivity by Reflective Tape Model' table before using the tape.

※2: Non-glossy white paper 100×100mm.

※3: Non-glossy white paper 200×200mm.

※4: M12 connector cable is sold separately.

※5: The weight includes packaging. The weight in parenthesis is for unit only.

※ The temperature and humidity mentioned in Environment indicates a non freezing or condensation.

Cylindrical Type Photoelectric Sensor (Side Sensing Type)

■ Dimensions

(unit: mm)

◎ Through-beam type

● BRQPS□-TDTA(-P)

• Emitter



● BRQPS□-TDTA-C(-P)

• Emitter



• Receiver



• Receiver



◎ Retroreflective/Diffuse reflective type

● BRQPS□-DDTA(-P)

● BRQPS3M-PDTA(-P)



● BRQPS□-DDTA-C(-P)

● BRQPS3M-PDTA-C(-P)



SENSORS

CONTROLLERS

MOTION DEVICES

SOFTWARE

(A) Photoelectric Sensors

(B) Fiber Optic Sensors

(C) LIDAR

(D) Door/Area Sensors

(E) Vision Sensors

(F) Proximity Sensors

(G) Pressure Sensors

(H) Rotary Encoders

(I) Connectors/ Connector Cables/ Sensor Distribution Boxes/ Sockets

BRQ Series

• M18 fixing nut



• Reflector

(unit: mm)

• MS-2S



◎ Sold separately

• Bracket(BK-BR-A)



• Reflective tape



(unit: mm)

Model	A
MST-50-10	□50
MST-100-5	□100
MST-200-2	□200

• Connection cable

• CIDH4-□



• CLDH4-□



※Specification of connector cable: Ø6mm, 4-wire, 2m/3m/5m/7m
(AWG22, core diameter: 0.08mm, number of cores: 60, insulator out diameter: Ø1.65mm)

Cylindrical Type Photoelectric Sensor (Side Sensing Type)

■ Feature Data

◎ Diffuse reflective type

● BRQPS100-DDTA-□(-P)

● BRQPS400-DDTA-□(-P)

● BRQPS700-DDTA-□(-P)



◎ Retroreflective type

● BRQPS3M-PDTA-□(-P)



◎ Through-beam type

● BRQPS10M-TDTA-□(-P)

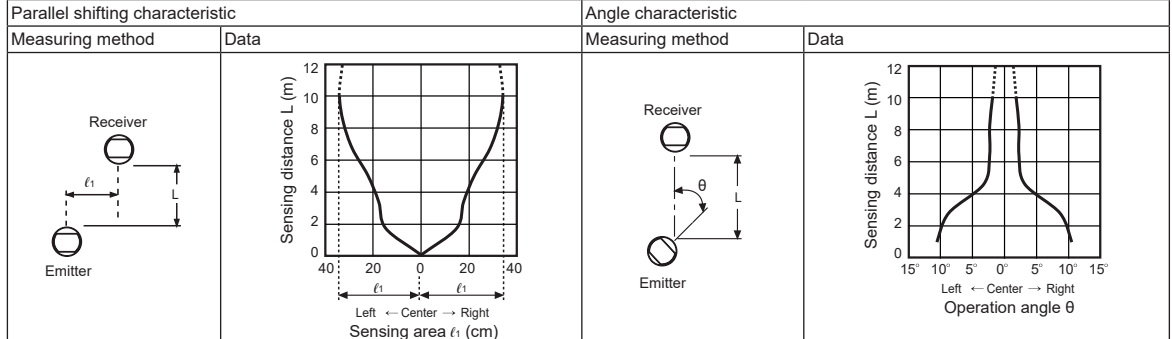

● BRQPS20M-TDTA-□(-P)



SENSORS

CONTROLLERS

MOTION DEVICES

SOFTWARE

(A) Photoelectric Sensors

(B) Fiber Optic Sensors

(C) LIDAR

(D) Door/Area Sensors

(E) Vision Sensors

(F) Proximity Sensors

(G) Pressure Sensors

(H) Rotary Encoders

(I) Connectors/ Connector Cables/ Sensor Distribution Boxes/ Sockets

BRQ Series

Control Output Circuit Diagram

Through-beam/Retroreflective/Diffuse reflective type



※Before using this unit, select Light ON/Dark ON with control wire. (Light ON: connect control wire to 0V/Dark ON: connect control wire to +V)
 ※If short-circuit the control output terminal or supply current over the rated specification, normal control signal is not output due to the output short over current protection circuit

Connections for Connector Part



M12 Connector pin

Pin No.	Cable color	Application Diffuse/ Retroreflective type	Through-beam type	
			Emitter	Receiver
1	Brown	30VDC	30VDC	30VDC
2	White	CONTROL	N.C	CONTROL
3	Blue	GND	GND	GND
4	Black	OUTPUT	N.C	OUTPUT

● Connector cable (sold separately)
 ※Please refer to the connector cable part.

Operation Timing Diagram

Through-beam type



Retroreflective/Diffuse reflective type



※The waveforms of 'Operation indicator' and 'Transistor output' are for Light ON operation.
 The waveforms are reversed in Dark On operation.

Cylindrical Type Photoelectric Sensor (Side Sensing Type)

■ Connections

• Through-beam type

<Cable type>



<Connector type>



• Retroreflective type

<Cable type>

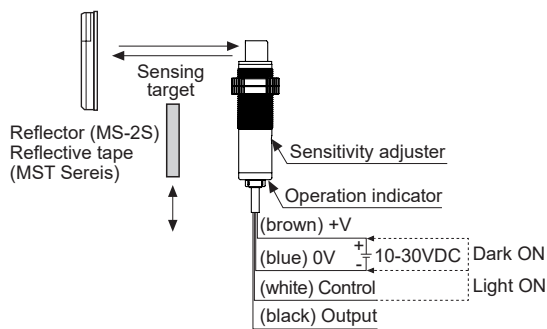

<Connector type>

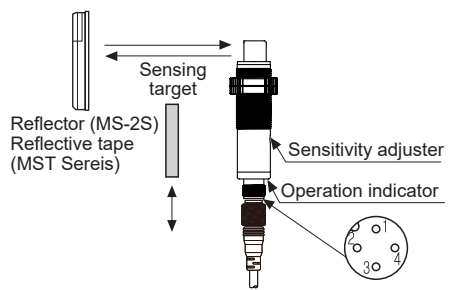

• Diffuse reflective type

<Cable type>

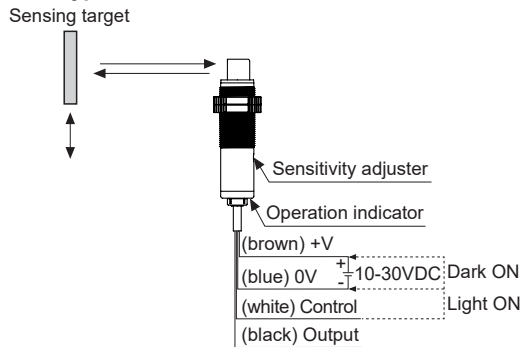

<Connector type>

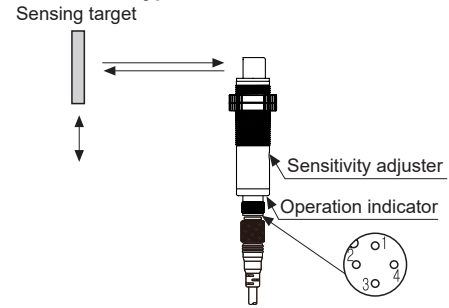

SENSORS

CONTROLLERS

MOTION DEVICES

SOFTWARE

(A) Photoelectric Sensors

(B) Fiber Optic Sensors

(C) LIDAR

(D) Door/Area Sensors

(E) Vision Sensors

(F) Proximity Sensors

(G) Pressure Sensors

(H) Rotary Encoders

(I) Connectors/
Connector Cables/
Sensor Distribution
Boxes/ Sockets

BRQ Series

■ Installation and Adjustment

Install the sensor to the desired place and check the connections.

Supply the power to the sensor and adjust the optical axis and the sensitivity as following.

When using the reflective type photoelectric sensors closely over three units, it may result in malfunction due to mutual interference.

When using the through-beam type photoelectric sensors closely over two units, it may result in malfunction due to mutual interference.

When installing the product, tighten the fixing nuts with a tightening torque of 0.39N·m.

◎ Through-beam type

1. Supply the power to the photoelectric sensor, after setting the emitter and the receiver facing each other.
 2. Set the receiver in center of position in the middle of the operation range of indicator adjusting the receiver or the emitter right and left, up and down.
 3. After adjustment, check the stability of operation putting the object at the optical axis.
- ※If the sensing target is translucent body or smaller than $\varnothing 7\text{mm}$, it can be missed by sensor cause light penetrate it.

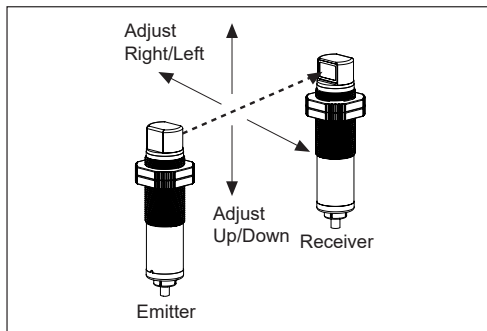

◎ Retroreflective type

1. Supply the power to the photoelectric sensor, after setting the photoelectric sensor and the reflector (MS-2S) or reflective tape in face to face.
 2. Set the photoelectric sensor in the position which indicator turns on, as adjusting the reflector or the sensor right and left, up and down.
 3. Fix both units tightly after checking that the unit detects the target.
- ※Sensitivity adjustment : Refer to the diffuse reflective type's.

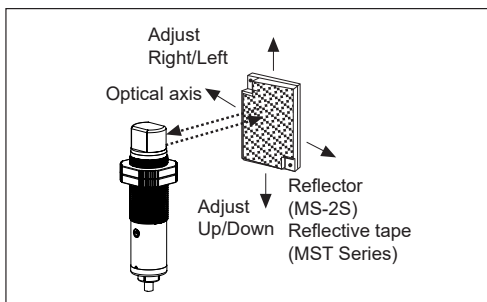

◎ Diffuse reflective type

1. The sensitivity should be adjusted depending on a sensing target or mounting place.
 2. Set the target at a position to be detected by the beam, then turn the sensitivity adjuster until position ㊸ where the operation indicator turns ON from min. position of the sensitivity adjuster.
 3. Take the target out of the sensing area, then turn the sensitivity adjuster until position ㊹ where the the operation indicator turns ON.
- If the indicator dose not turn ON, max. position is ㊺.
4. Set the sensitivity adjuster at the center of two switching position ㊸, ㊹.
- ※Be aware of the fact that sensing distance can be different by size, surface and gloss of the target.

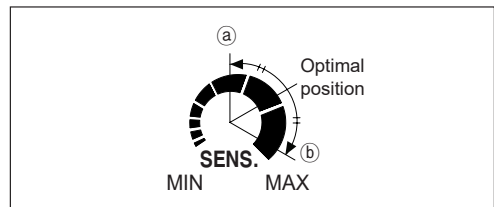

■ Reflectivity by Reflective Tape Model

MST-50-10 (50×50mm)	25%
MST-100-5 (100×100mm)	30%
MST-200-2 (200×200mm)	35%

- ※This reflectivity is based on the reflector (MS-2S).
 ※Reflectivity may vary depending on usage environment and installation conditions.
 The sensing distance and minimum sensing target size increase as the size of the tape increases.
 Please check the reflectivity before using reflective tapes.
 ※For using reflective tape, installation distance should be min. 20mm.